

IBM Network Station Family of Thin Clients
Access for today, flexibility for tomorrow



Network Station Device Attachment

September 7, 1999





Series 300 Device Attachment

Network Station Manager V1R3 and V2R1

Series 300

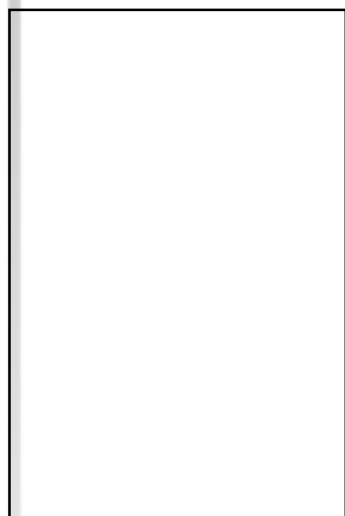

PS/2 KB port

□ 102 Key

Token Ring

Ethernet

□ Addonics,
3 Com hubs,
dialers

PCMCIA

□ Quatech serial cards
1, 2, 4 ports

□ Flash card

Serial

Parallel

□ Printer

VGA port

□ Monitor

Mouse port

□ Touch screen
monitor

□ Light pen interface
Y connector

□ Light pen interface
Y connector

□ Light pen external
interface

□ PS/2 mouse

□ Light pen

■ GCR Smart-
card reader

■ Touch screen
touch sensor

□ Printer

□ Other serial
devices

□ Other serial
devices

■ GCR Smart-
card reader

□ Printer

□ Touch screen
touch sensor

□ V1R3 and V2R1 attachment support

■ V2R1 attachment support only





Series 1000 Device Attachment

Network Station Manager V1R3 and V2R1

Series 1000

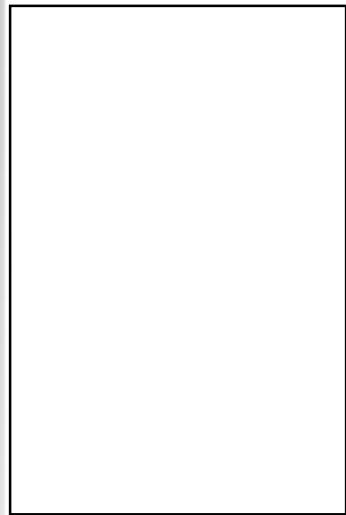

PS/2 KB port

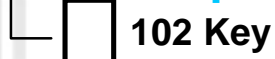

102 Key

Token Ring

Ethernet



Addonics,
3 Com hubs,
dialers

Internal Smart-card reader



PCMCIA



Quatech serial cards
1, 2, 4 ports



Flash card

Serial

Parallel



Printer

VGA port



Monitor

Mouse port



Touch screen
monitor



Light pen interface
Y connector



PS/2 mouse



Light pen interface
Y connector



Light pen external
interface



Light pen



GCR Smart-card reader

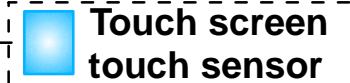

Touch screen touch sensor



Printer



Other serial devices



Other serial devices



GCR Smart-card reader



Printer



Touch screen touch sensor

 V1R3 and V2R1 attachment support

 V2R1 attachment support only



Series 2800 Device Attachment

Network Station Manager V2R1

Series 2800

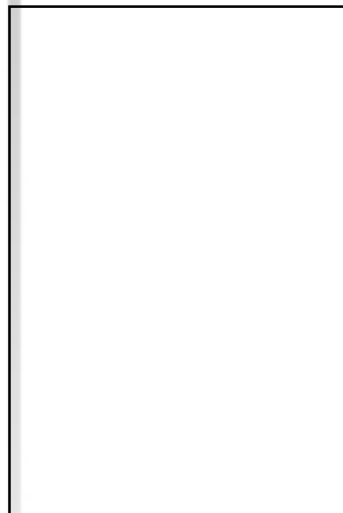

Internal Compact Flash socket

Compact Flash card

2 internal PCI slots

Quatech PCI serial cards 2, 4, 8 ports

Quatech PCI serial cards 2, 4, 8 ports

Serial 1
Serial 2

Parallel

Printer

VGA port

Monitor

Mouse port

Touch screen monitor

Other serial devices

GCR Smart-card reader

Printer

Touch screen touch sensor

PS/2 KB port

102 Key

Token Ring

Ethernet

Addonics,
3 Com hubs,
dialers

Light pen interface
Y connector

Light pen interface
Y connector

Light pen external
interface

PS/2 mouse

Light pen

2 USB Ports

SW support TBD

V2R1 attachment support





Series 2200 Device Attachment

Network Station Manager V2R1

Series 2200

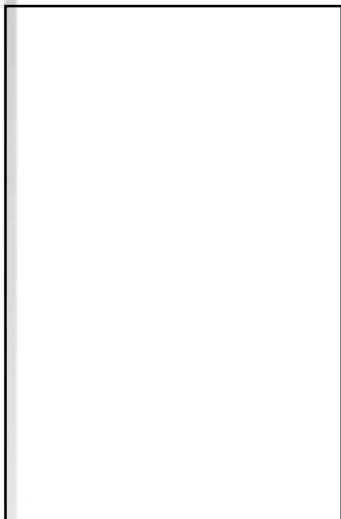

Internal Compact Flash socket

Compact Flash card

USB 2

Pick One

USB to Parallel converter cable (order from Options by IBM)

Printer

USB to Serial or USB to parallel -- mutually exclusive

USB to Serial converter cable (order from Options by IBM)

Printer

VGA port

Monitor

Or

~~GCR Smart-card reader~~

Or

Other serial devices

*USB to serial device support post V2R1 GA.
Series 2200 can support one serial device via USB to serial converter cable*

Token Ring
Ethernet

Addonics, 3 Com hubs, dialers

USB 1

102 Key USB keyboard

PS/2 mouse (via USB keyboard)

V2R1 attachment support

PS/2-style wedge devices not supported







Device Support Categories

- **General**
- **Printing**
- **Multiple serial ports**
- **Java Comm API's**
- **USB**
- **SmartCard**
- **Touch Screen**
- **Light pen**



General Device Attachment Summary

	Series 300		Series 2200		Series 1000		Series 2800	
	V1R3	V2R1	V1R3	V2R1	V1R3	V2R1	V1R3	V2R1
Quatech PCMCIA multi serial cards	✓	✓	n/a	✗	✓	✓	n/a	✗
Quatech PCI multi serial cards	✗	✗	n/a	✗	✗	✗	n/a	✓
Serial 1 native port	✓	✓	n/a	✗	✓	✓	n/a	✓
Serial 2 native port	✗	✗	n/a	✗	✗	✗	n/a	✓
Maximum number of serial ports	5	5	n/a	0	5	5	n/a	18
Parallel native port	✓	✓	n/a	✗	✓	✓	n/a	✓
3 Com, Addonics dialers, hubs	✓	✓	n/a	✓	✓	✓	n/a	✓
Java Comm device API's support		✓	n/a	✓		✓	n/a	✓
Touch screen - IBM Micro Touch	✓	✓	n/a	✗	✓	✓	n/a	✓
Touch Screen - ELO		✓	n/a	✗		✓	n/a	✓
JavaX.COMM for Smart Card	✗	✓	n/a		✗	✓	n/a	✓
Light Pen		✓	n/a	✗		✓	n/a	✓
USB keyboard	✗	✗	n/a	✓	✗	✗	n/a	✗
USB to parallel converter cable	✗	✗	n/a	✓	✗	✗	n/a	✗
USB to serial converter cable	✗	✗	n/a	✓	✗	✗	n/a	✗
USB hubs	✗	✗	n/a		✗	✗	n/a	✗

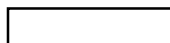
 Supported
  Not supported
  May work, not supported





Java Comm API's

Use Java to develop device drivers

- **Java communication API's for**
 - ▶ **Serial ports**
 - ▶ **Parallel ports**
- **Packaged as javax.comm**
- **In V1R3, serial output only supported via a special bid**
- **In V2R1, full 2.0 API interface supported**
 - ▶ **Port ownership notifications**
 - **Inter-JVM**
 - **Intra-JVM**
 - ▶ **Event notification for**
 - **State changes**
 - **Incoming data**
 - **Output buffer drains**



Devices Supported by V2R1 Java Comm API's

Use Java to develop device drivers

OCF

Java Applications

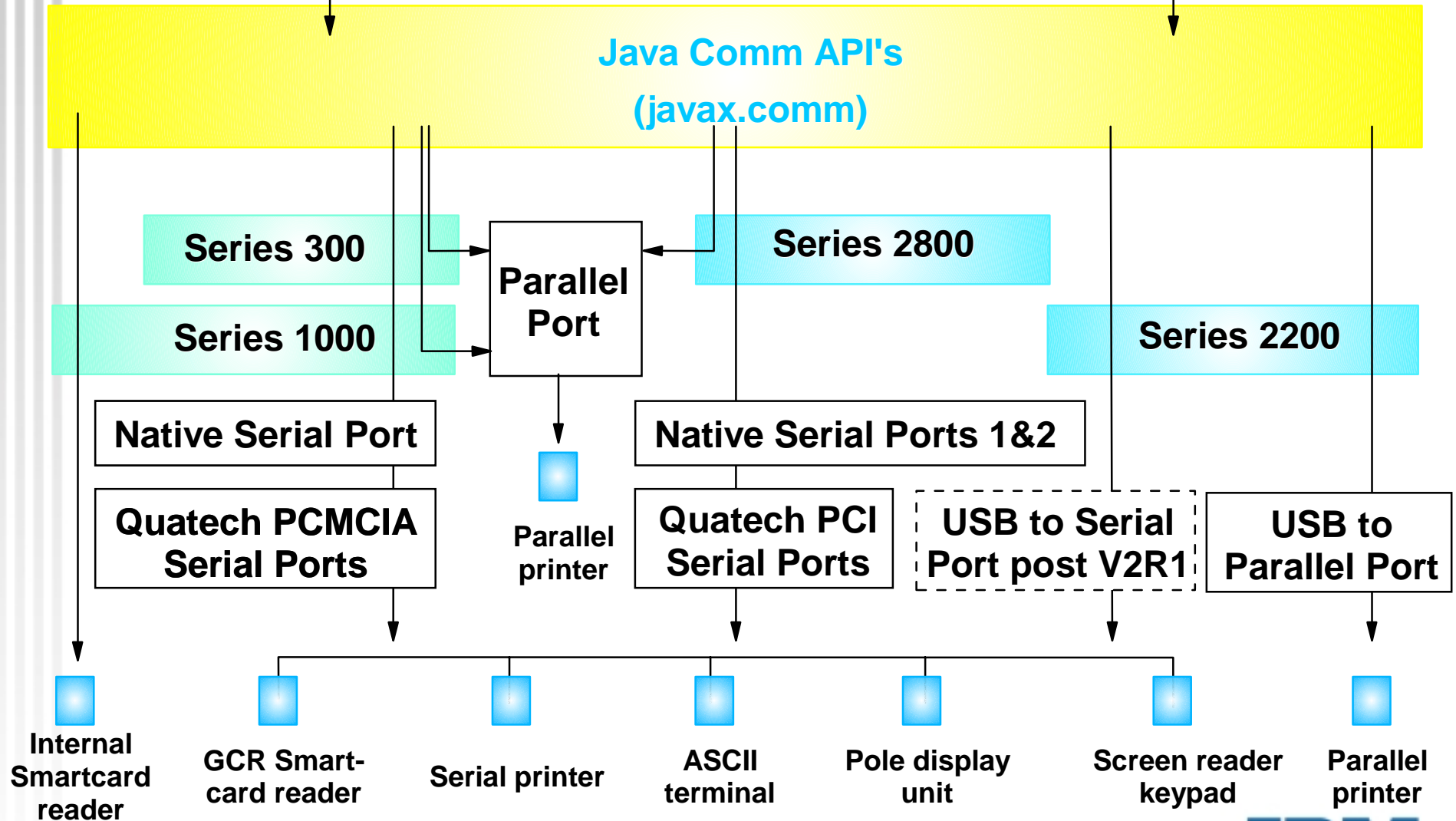



Java Comm APIs

IBM Network Station Family of Thin Clients

javax.comm Class Hierarchy

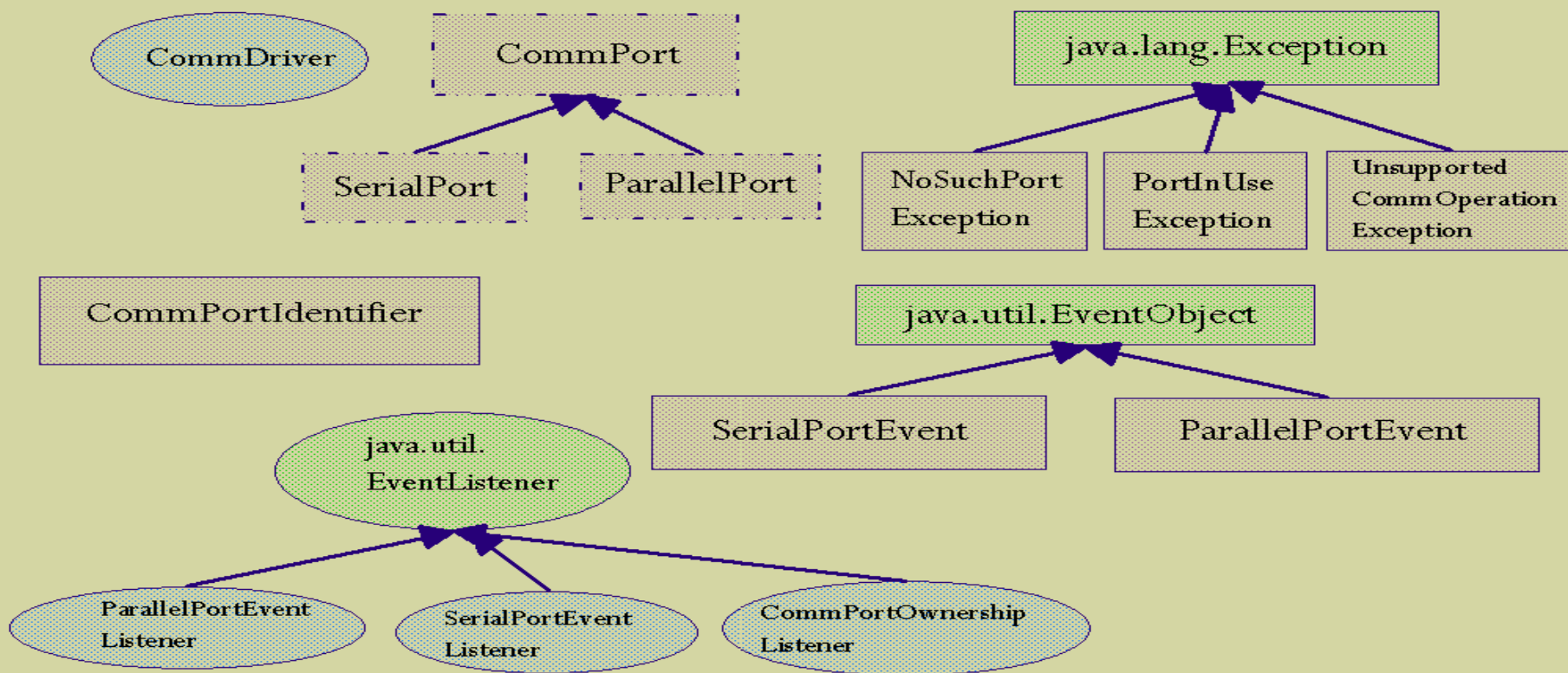



Port Mapping in V2R1 Java Comm API's

IBM Network Station Family of Thin Clients

	Series 300	Series 2200	Series 1000	Series 2800
Native Parallel Port (/dev/lpt0)	LPT1	NA	LPT1	LPT1
Internal SmartCard Reader Port (/dev/sc0)	NA	NA	SC1	NA
Native Serial Port 1 (/dev/tty00)	COM1	NA	COM1	COM1
Native Serial Port 2 (/dev/tty01)	NA	NA	NA	COM2
USB / Parallel Port (/dev/ulpt0)	NA	LPT1	NA	NA
USB / Serial Port (/dev/utty00)	NA	COM1	NA	NA
Quatech (PCI / PCMCIA) Serial Port 1 (/dev/tty01 or 2)	COM2	NA	COM2	COM3
Quatech (PCI / PCMCIA) Serial Port 4 (/dev/tty04 or 5)	COM5	NA	COM5	COM6
Quatech (PCI) Serial Port 5 (/dev/tty05 or 6)	NA	NA	NA	COM7
Quatech (PCI) Serial Port 16 (/dev/tty16 or 17)	NA	NA	NA	COM18



SmartCard Enablement

IBM Network Station Family of Thin Clients

- **JavaX.COMM support for SmartCard readers in V2R1**
 - ▶ **GCR410 reader supported by OpenCard Consortium**
 - **Connects to serial port across all Network Stations**
 - ▶ **Series 1000 internal SmartCard reader not supported by OCF**
- **No SmartCard enablement in V1R3**

	Series 300		Series 2200		Series 1000		Series 2800	
	V1R3	V2R1	V1R3	V2R1	V1R3	V2R1	V1R3	V2R1
GCR410 Reader - OCF device driver	✗		n/a		✗		n/a	
GCR410 Reader - Javax.comm	✗	✓	n/a	✓	✗	✓	n/a	✓
Internal Reader - OCF device driver	✗	✗	n/a	✗	✗		n/a	✗
Internal Reader - Javax.comm	✗	✗	n/a	✗	✗	✓	n/a	✗

✓ Supported
 ✗ Not supported
 May work, not supported



V2R1 Printing Summary

IBM Network Station Family of Thin Clients

- **V2R1 provides generic support for**
 - ▶ **PostScript**
 - ▶ **PCL (emulators only)**
 - ▶ **ASCII (emulators only)**
- **Applications that support printing**
 - ▶ **Netscape Communicator**
 - ▶ **Terminal emulators**
 - ▶ **JVM**
 - ▶ **ICA**
 - ▶ **Command line interface**
 - ▶ **Seriald**
 - ▶ **Remote printing**
- **New features in V2R1**



New Print Features in V2R1

IBM Network Station Family of Thin Clients

- **Print queue / job monitoring and canceling**
 - ▶ **Print Monitor icon in desktop toolkit**
- **Printing enabled for additional ports**
 - ▶ **Serial 2 on Series 2800**
 - ▶ **Up to 16 Quatech serial ports on Series 2800**
 - ▶ **USB to parallel converter cables on Series 2200**
 - ▶ **USB to serial converter cables on Series 2200 post V2R1 GA**
- **Multiple copy printing in**
 - ▶ **Netscape Communicator**
 - ▶ **Calendar**
 - ▶ **Other applications**
- **LPD printing, PostScript, and PCL printing in VTxxx emulators**
- **Serial printer option settings in NSM**
 - ▶ **Baud rate**
 - ▶ **Parity, etc.**



Printing Comparison Summary

IBM Network Station Family of Thin Clients

	Series 300		Series 2200		Series 1000		Series 2800	
	V1R3	V2R1	V1R3	V2R1	V1R3	V2R1	V1R3	V2R1
PostScript	✓	✓	n/a	✓	✓	✓	n/a	✓
Parallel port	✓	✓	n/a	✗	✓	✓	n/a	✓
Serial port	✓	✓	n/a	✗	✓	✓	n/a	✓
USB to parallel	✗	✗	n/a	✓	✗	✗	n/a	✗
USB to serial	✗	✗	n/a	✓	✗	✗	n/a	✗
Quatech PCMCIA / PCI	✓	✓	n/a	✗	✓	✓	n/a	✓
Remote / network	✓	✓	n/a	✓	✓	✓	n/a	✓
Seriald	✓	✓	n/a	✓	✓	✓	n/a	✓
Command line	✗	✓	n/a	✓	✗	✓	n/a	✓
PCL	1	1	n/a	1	1	1	n/a	1
ASCII	1	1	n/a	1	1	1	n/a	1
ASCII DBCS	1	✗	n/a	✗	1	✗	n/a	✗

1. emulators only

Supported	Not supported	May work, not supported
-----------	---------------	-------------------------



Printing in Terminal Emulators

IBM Network Station Family of Thin Clients

	Series 300		Series 2200		Series 1000		Series 2800	
	V1R3	V2R1	V1R3	V2R1	V1R3	V2R1	V1R3	V2R1
PostScript	✓	✓	n/a	✓	✓	✓	n/a	✓
PCL	✓	✓	n/a	✓	✓	✓	n/a	✓
ASCII	✓	✓	n/a	✓	✓	✓	n/a	✓
ASCII DBCS	✓	✗	n/a	✗	✓	✗	n/a	✗
Parallel port	✓	✓	n/a	✗	✓	✓	n/a	✓
Serial port	✓	✓	n/a	✗	✓	✓	n/a	✓
Quatech serial port	✓	✓	n/a	✗	✓	✓	n/a	✓
USB to parallel	✗	✗	n/a	✓	✗	✗	n/a	✗
USB to serial	✗	✗	n/a	✓	✗	✗	n/a	✗
Remote / network - 5250	✓	✓	n/a	✓	✓	✓	n/a	✓
Remote / network - 3270	✓	✓	n/a	✓	✓	✓	n/a	✓
Remote / network - VT xxx		✓	n/a	✓		✓	n/a	✓

✓ Supported	✗ Not supported	<input type="checkbox"/> May work, not supported
-------------	-----------------	--------------------------------------------------



Printing in V2R1 for S/2800, S/1000, S/300

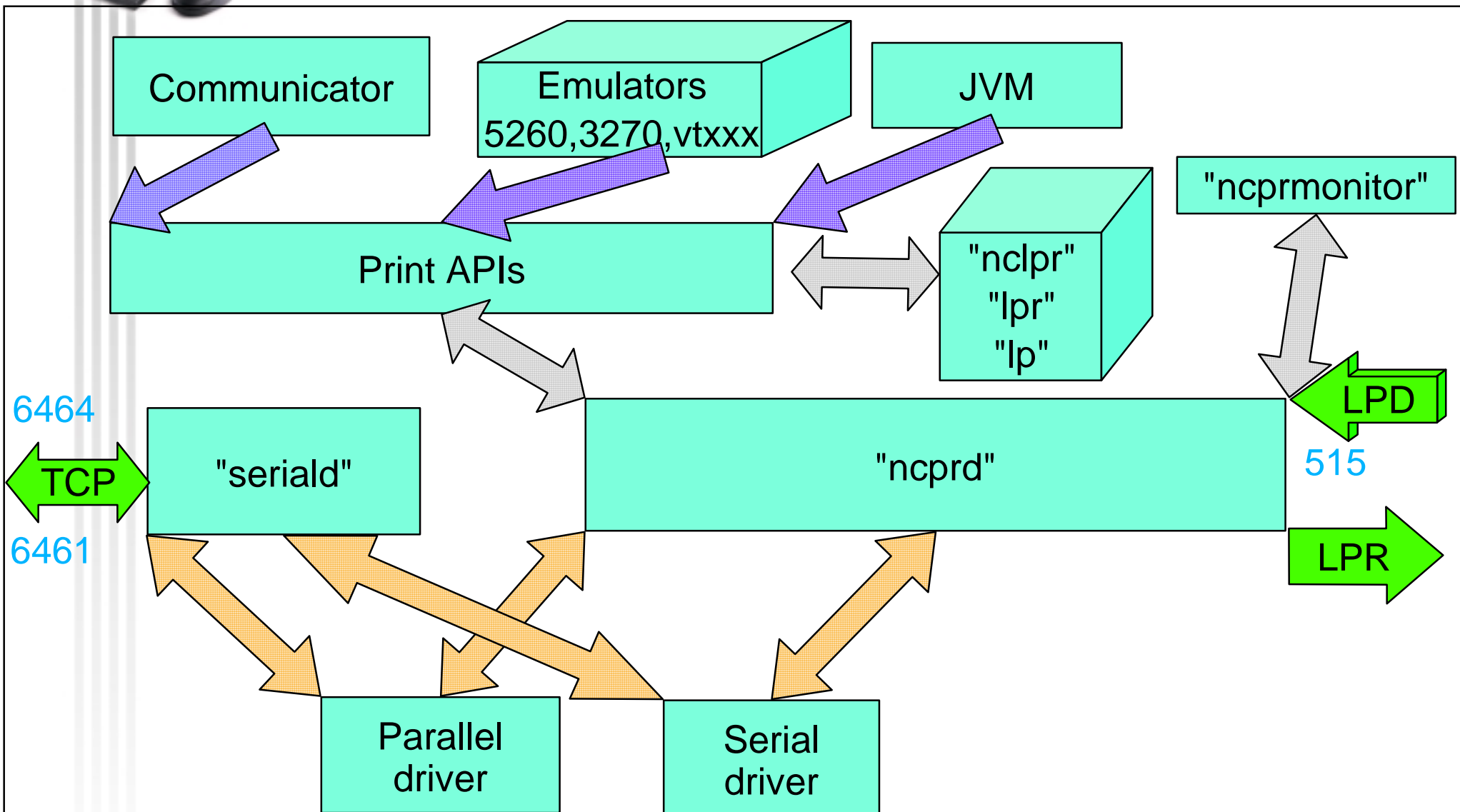



Printing in V2R1 for S/2200

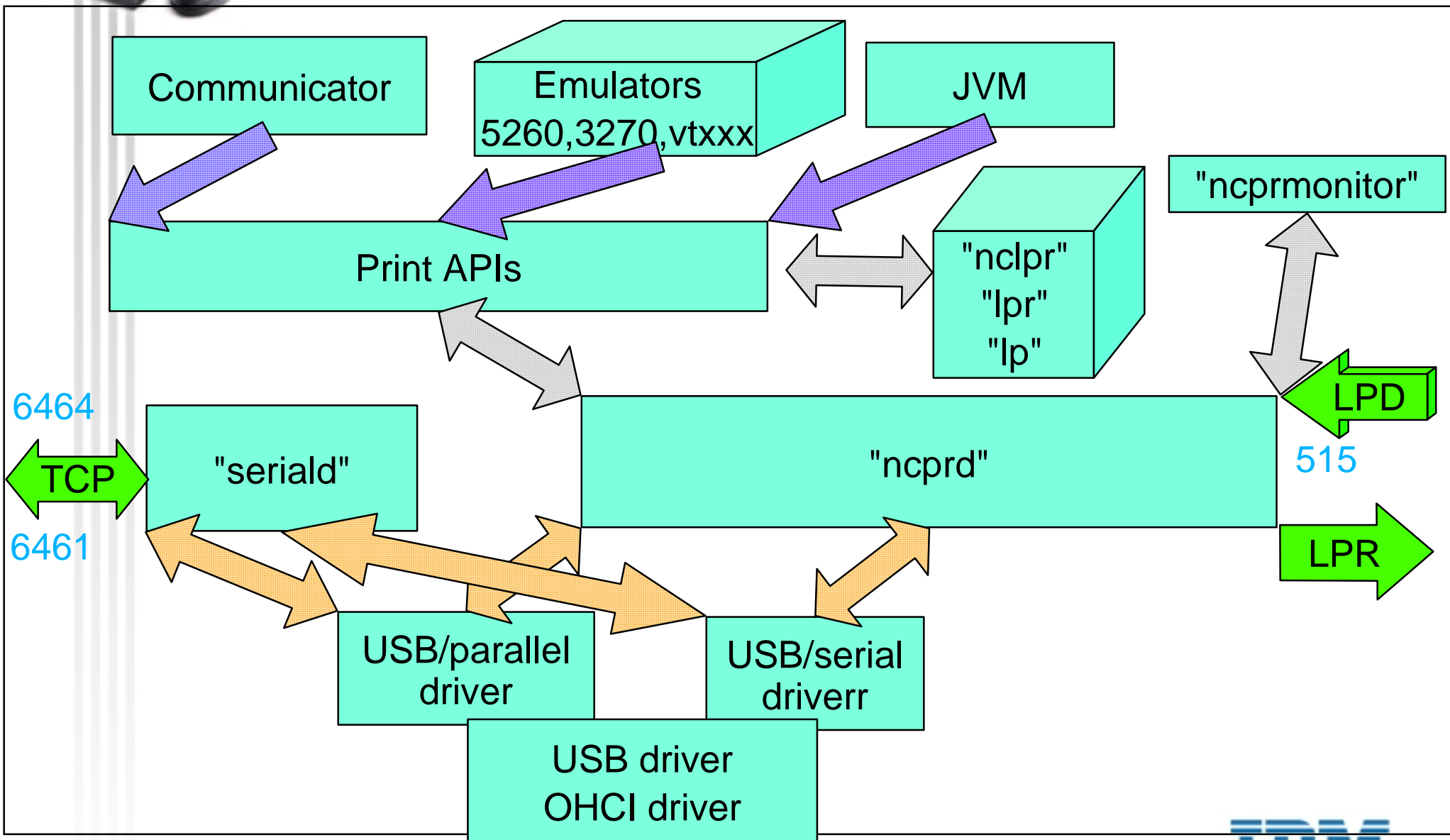



NSM Configuration Parameters for Printing

IBM Network Station Family of Thin Clients

- **Print queues**
 - ▶ **print-lpr-servers (default: PARALLEL1 and SERIAL1)**
- **Serial ports**
 - ▶ **serial-interfaces-table (9600, none, 8, 1, etc)**
- **Seriald daemon**
 - ▶ **parallel-daemons-table (5964)**
 - ▶ **serial-daemons-table (87, 5962, etc)**
 - ▶ **serial-access-control-enabled**
 - ▶ **serial-access-control-list**
- **Remote printing**
 - ▶ **print-access-control-enabled (for LPD)**
 - ▶ **print-access-control-list (for LPD)**
 - ▶ **print-lpd-cache-size (for LPD)**
 - ▶ **print-lpd-stream-large-jobs (for LPD)**
 - ▶ **print-lprd-cache-size (for LPR)**



Printing in Netscape Communicator 4.5 and JVM 1.1.8 in V2R1 and JVM 1.1.6 in V1R3

- **PostScript printing**
- **Remote printing to OS/400, AIX, OS/390, NT servers and network printers**
- **Parallel, serial, and Quatech-serial attached printers**
 - ▶ **Series 300, Series 1000 in V1R3 and V2R1**
 - ▶ **Series 2800 in V2R1**
- **USB to parallel attached printers**
 - ▶ **Series 2200 in V2R1**
- **USB to serial attached printers**
 - ▶ **Series 2200 in V2R1 post V2R1 GA**



Printing in ICA Client

- **Printer drivers on the ICA servers**
- **Remote printing on the ICA servers**
- **Parallel, serial, and Quatech-serial attached printers**
 - ▶ **Series 300, Series 1000 in V1R3 and V2R1**
 - ▶ **Series 2800 in V2R1**
- **USB to parallel attached printers**
 - ▶ **Series 2200 in V2R1**
- **USB to serial attached printers**
 - ▶ **Series 2200 in V2R1 post V2R1 GA**



Serial Daemon Functions

- **TCP socket based**
- **pass-through mode or command (protocol) mode**
- **protocol commands**
 - ▶ **read port status (synchronous)**
 - ▶ **read port status (asynchronous)**
 - ▶ **write data block**
 - ▶ **write data block with a timer**
 - ▶ **raise/lower modem control signals**
 - ▶ **query number of bytes in output buffer**
 - ▶ **query output buffer free space**
 - ▶ **generate break**
 - ▶ **drain output buffer**
 - ▶ **get/set port attributes**
 - ▶ **get parity error notifications**



Port Mapping in V2R1 SerialId

IBM Network Station Family of Thin Clients

	Series 300	Series 2200	Series 1000	Series 2800
Native Parallel Port (/dev/lpt0)	6464 (5964)	NA	6464 (5964)	6464 (5964)
Internal SmartCard Reader Port (/dev/sc0)	NA	NA	6462 (5962)	NA
Native Serial Port 1 (/dev/tty00)	6461 (87)	NA	6461 (87)	6461 (87)
Native Serial Port 2 (/dev/tty01)	NA	NA	NA	6462 (5962)
USB / Parallel Port (/dev/ulpt0)	NA	6464 (5964)	NA	NA
USB / Serial Port (/dev/utty00)	NA	6461 (87)	NA	NA
Quatech (PCI / PCMCIA) Serial Port 1 (/dev/tty01 or 2)	6462 (5962)	NA	6463 (5963)	6463 (5963)
Quatech (PCI / PCMCIA) Serial Port 4 (/dev/tty04 or 5)	6467 (5967)	NA	6468 (5968)	6468 (5968)
Quatech (PCI) Serial Port 5 (/dev/tty05 or 6)	NA	NA	NA	6469 (5969)
Quatech (PCI) Serial Port 16 (/dev/tty16 or 17)	NA	NA	NA	6480 (5980)



Multiple Serial Ports

- **Number of native serial ports**
 - ▶ 1 for Series 300 and Series 1000 in V2R1 and V1R3
 - ▶ 2 for Series 2800 in V2R1
- **Additional serial ports via Quatech cards**
 - ▶ PCMCIA for Series 300 and Series 1000 in V2R1 and V1R3
 - ▶ PCI for Series 2800 in V2R1 (upto two cards at the same time)
- **Quatech PCMCIA cards for Series 300 and Series 1000**
 - ▶ SSP-100 Single Channel RS-232 PCMCIA card
 - ▶ DSP-100 Dual Channel RS-232 PCMCIA card
 - ▶ QSP-100 Four Channel RS-232 PCMCIA card
- **Quatech PCI cards for Series 2800**
 - ▶ DSC-100 2 port RS-232 PCI adapter
 - ▶ QSC-100 4 port RS-232 PCI adapter
 - ▶ ESC-100 8 port RS-232 PCI adapter
 - ▶ ESC-100M 8 port RS-232 PCI adapter with modular connectors



USB Support

- **Only for Series 2200 in V2R1**
- **Officially supported in V2R1 or post GA-PTF**
 - ▶ IBM USB keyboards with PS/2 mouse attachments
 - ▶ Belkin's USB/Parallel Adapter - F5U002
 - ▶ Belkin's USB/Serial Adapter - F5U003 USB Serial Adapter
 - ▶ Entrega's USB/Parallel Adapter - CON-USB-P36
 - ▶ Low speed (1.5 Mbps) and high speed (12 Mbps)
- **May work, but not supported**
 - ▶ Other USB keyboards
 - ▶ Other USB mice
 - ▶ Other USB/Parallel adapters and USB printers
 - ▶ Hubs (self-powered and bus-powered)
- **Future support (post-GA PTFs and V2R2)**
 - ▶ Entrega's USB/Serial Adapters - CON-USB-S9, S25
 - ▶ Hubs, and hubs with P/S ports - Entrega's 2U4S, 4U2S1P
 - ▶ Hot-plugging
 - ▶ USB modems, joysticks, speakers, Zip drive, etc
 - ▶ USB device support in Series 2800



Touch Screen Support

- **Touch screen supported on the following models**
 - ▶ **Series 300**
 - ▶ **Series 1000**
 - ▶ **Series 2800**
- **Touch screen support in V1R3**
 - ▶ **only for IBM (Micro) Touch Monitors**
 - ▶ **touch sensor only for serial port 1**
 - ▶ **Quatech ports not supported for touch sensor**
- **Touch screen support in V2R1**
 - ▶ **for IBM (Micro) Touch and ELO Touch Monitors**
 - ▶ **touch sensor for any serial port (not via NSM)**
 - ▶ **Quatech ports also supported for touch sensor (not via NSM)**
- **Touch monitors supported**
 - ▶ **IBM G70 t, G42, G54, G74, G94, Flat panel T55A**
 - ▶ **ELO IntelliTouch Ultra**



Touch Screen Calibration

- **Touch screen calibration in V1R3**
 - ▶ **Done via Setup dialog in console**
 - console -> setup -> change setup ->
 - input extension device -> calibrate touchscreen
- **Touch screen calibration in V2R1**
 - ▶ **Done via GUI**
 - Desk top task bar -> Toolkit -> Calibration Tools
 - ▶ **Command line interface**
 - /usr/local/nc/bin/calibrate
 - ▶ **Automatically done by the touch daemon the first time**
 - /usr/local/nc/bin/ibmtouchdaemon
 - /usr/local/nc/bin/elotouchdaemon



Touch Screen Setup

- **Touch screen setup in V1R3**
 - ▶ **Set up the serial port as input device**
 - console -> setup -> change setup ->
 - serial -> serial interfaces table
 - ▶ **Set up the input device as IBM touch screen**
 - console -> setup -> change setup ->
 - input extension device
 - ▶ **Set up the pointing device as "Mouse and Extension Device"**
 - console -> setup -> change user preferences
 - pointing devices -> current pointing device



Touch Screen Setup (contd.)

- **Touch screen setup in V2R1**
 - ▶ **Enable the touch daemon via NSM**
 - **Set preference level -> WorkStation**
 - **Hardware -> WorkStation -> Monitor Settings**
 - **type of monitor - IBM or ELO Touch screen**
 - ▶ **Optionally, the touch daemon can be started from the command line**
 - **/usr/local/nc/bin/ibmtouchdaemon**
 - **/usr/local/nc/bin/elotouchdaemon**
 - **specify the serial port to be used (ex: /dev/tty00)**



Lightpen Support

- **Works in V1R3, but not officially supported**
- **Fully supported in V2R1**
- **Lightpen specification**
 - ▶ **made by FTG Data Systems**
 - ▶ **FX - 431**
 - ▶ **FX - 421 (also known as 7421-NC)**
- **Lightpen interface specification**
 - ▶ **external with mouse and video attachments**
 - ▶ **made by FTG Data Systems**
 - ▶ **PXL 795U-NC**



Lightpen Calibration

- **Lightpen calibration in V1R3**
 - ▶ **Done via setup in console**
 - console -> setup -> change setup
 - input extension device -> calibrate light pen
- **Lightpen calibration in V2R1**
 - ▶ **Done via GUI**
 - Desk top task bar -> Toolkit -> Calibration Tools
 - ▶ **Command line interface**
 - /usr/local/nc/bin/calibrate
 - ▶ **Automatically done by the lightpen daemon the first time**
 - /usr/local/nc/bin/lightpentouchdaemon



Lightpen Setup

- **Lightpen setup in V2R1**
 - ▶ **Enable the lightpen daemon via NSM**
 - **Set preference level -> WorkStation**
 - **Hardware -> WorkStation -> Monitor Settings**
 - **type of monitor - light pen**
 - ▶ **Optionally, the lightpen daemon can be started from the command line**
 - **`/usr/local/nc/bin/lightpendaemon`**



Devices Used in Testing

- **Printers - parallel, serial and network**
 - ▶ HP Laserjet 6 MP, 5M, 5000, 5si, Color Laserjet, etc
 - ▶ Lexmark Optra 16
 - ▶ IBM Network Printer 17
 - ▶ IBM Proprinter XL24E
 - ▶ Epson LX - 800
- **ASCII terminals**
 - ▶ IBM 3151
 - ▶ Wyse 60
- **Touch screen terminals**
 - ▶ IBM G70t
- **SmartCard readers**
 - ▶ GCR 410 by Gemplus



Devices Used in Testing (contd.)

- **USB devices**
 - ▶ **Belkin's USB/Parallel Adapter - F5U002**
 - ▶ **Belkin's USB/Serial Adapter - F5U003 Serial Adapter**
 - ▶ **Belkin's 4-port ExpressBus Hub - F5U001**
 - ▶ **CATC's 4-port Hub - U-HUB-AN1**
 - ▶ **Entrega's USB/Parallel Adapter - CON-USB-P36**
 - ▶ **Microsoft USB keyboard**
 - ▶ **Microsoft USB mouse**
- **Lightpen attachment**
 - ▶ **interface - PXL-795**
 - ▶ **lightpen - FX-421**



Devices Used in Testing (contd.)

- **Others**
 - ▶ **Barcode Reader 9100 (keyboard wedge)**
 - ▶ **IBM Screenreader Keypad**
 - ▶ **DECExpress Text-to-Speech Synthesizer**